

# POWER DISTRIBUTION PEDESTALS



## PEDESTAL SOLUTIONS INC

*The Outdoor Enclosure & Power Distribution Experts*



**CANADIAN MADE**



# UN-METERED

**10 YEAR  
WARRANTY**

**PEDESTALS SOLUTIONS INC**

---

*The Outdoor Enclosure & Power Distribution Experts*



**CANADIAN MADE**





**Town of Halton Hills**



Your help and service this year was great! Our contractor and staff love the simplicity of the installation and use!

NEMA 3R LISTED  
10 YEAR WARRANTY

# SLS

Power Distribution Pedestal



## Features

- Complete with 2" PVC conduits for Line and Load Side conductors and a ground wire to bond the Neutral.
- Delivered "Ready to Install" with a Service Entrance rating, 22kA I.C. series rating, and ESA approval.
- Hardware to fasten pedestal to pre-cast concrete base is included with every pedestal (base available from many pre-cast concrete manufacturers).

### Typical Part Number

**SLS1-4-40(100)**

- SLS** - Street Lighting Short
- 1** - Number of first group of Load Breakers
- 4** - Quantity of Load Breakers
- 40** - Size of Load Breaker
- 100** - Size of Main Breaker

## → CONSTRUCTION

Constructed from heavy-gauge aluminum.

- Electrostatic powder coated "Equipment Green" as standard.
- All doors constructed to prevent weather intrusion without the means of a rubber gasket.
- Concealed Ventilation under lid to prevent condensation build-up.
- Stainless Steel fasteners used to mount all internal and external components.

## → MEASUREMENTS

Height - 27"

Width - 18"

Depth - 8"

## → TYPICAL USES

- Street Lighting Power
- Park Power
- Electric Car Charging
- Event Power

CALL US TODAY



**905-476-7433**



[info@pedestalsolutions.com](mailto:info@pedestalsolutions.com)



[www.pedestalsolutions.com](http://www.pedestalsolutions.com)

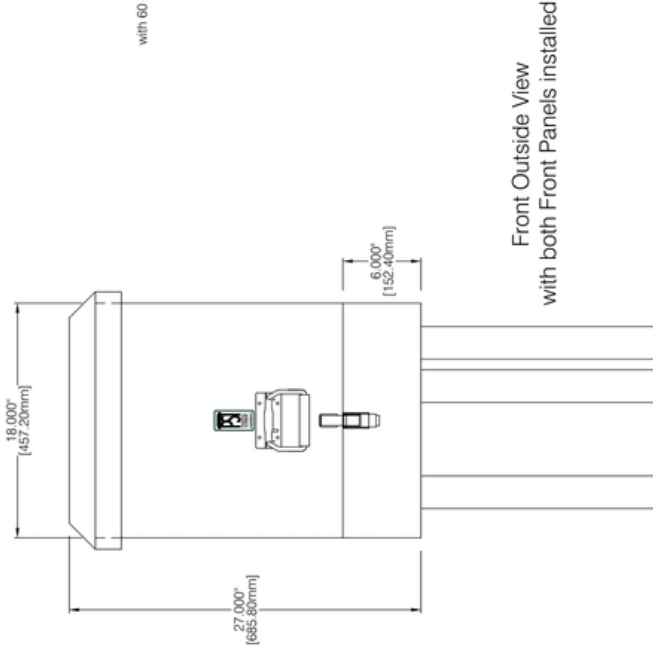
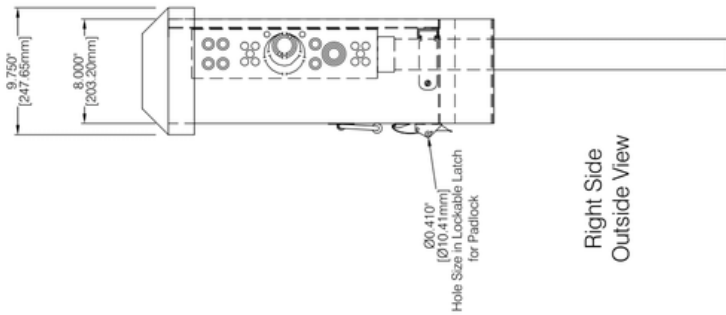
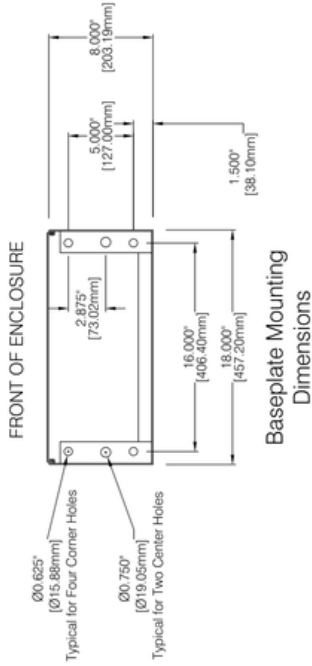
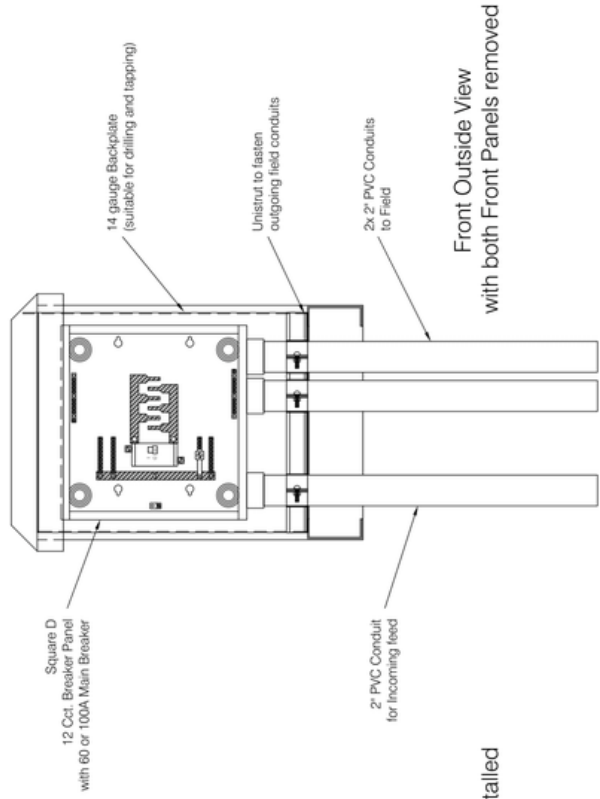
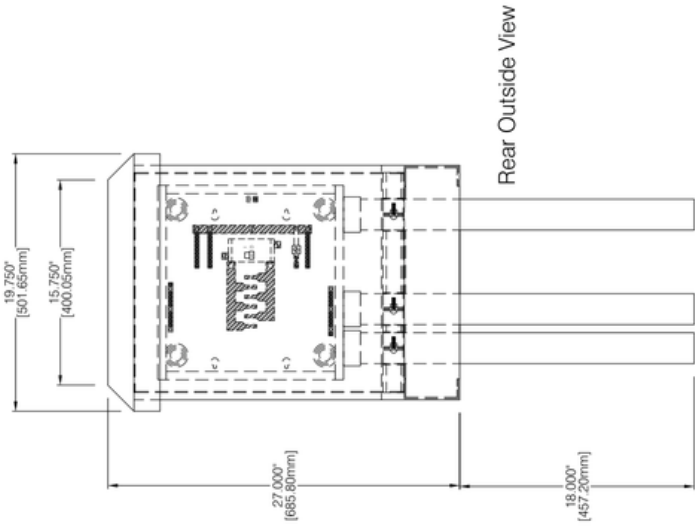

# SLS Un-metered Pedestal (Typical Layout)



**Makuta Electric LLC**



I have to say, I am very impressed with the product and your entire team. I will highly recommend your company to all my fellow electrical contractors in the area.

NEMA 3R LISTED  
10 YEAR WARRANTY

# SL42

## Power Distribution Pedestal



### Features

- Complete with 2" PVC conduits for Line and Load Side conductors and a ground wire to bond the Neutral.
- Delivered "Ready to Install" with a Service Entrance rating, 22kA I.C. series rating, and ESA approval.
- Hardware to fasten pedestal to pre-cast concrete base is included with every pedestal (base available from many pre-cast concrete manufacturers).

### → CONSTRUCTION

- Constructed from heavy-gauge aluminum.
- Electrostatic powder coated "Equipment Green" as standard.
  - All doors constructed to prevent weather intrusion without the means of a rubber gasket.
  - Concealed Ventilation under lid to prevent condensation build-up.
  - Stainless Steel fasteners used to mount all internal and external components.

### → MEASUREMENTS

Height - 42"  
Width - 18"  
Depth - 8"

### → TYPICAL USES

Street Lighting  
Park Power  
Electric Car Charging  
Event Power

### Typical Part Number

**SL421-4-40(100)**

- SL42** - Street Lighting 42" Pedestal
- 1** - Number of first group of Load Breakers
- 4** - Quantity of Load Breakers
- 40** - Size of Load Breaker
- 100** - Size of Main Breaker

CALL US TODAY

**905-476-7433**



[info@pedestalsolutions.com](mailto:info@pedestalsolutions.com)



[www.pedestalsoluitons.com](http://www.pedestalsoluitons.com)

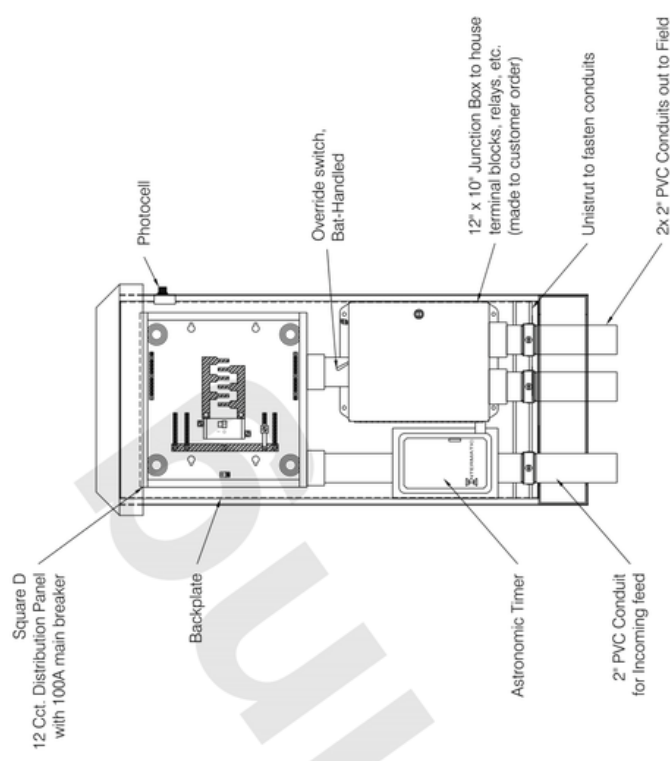
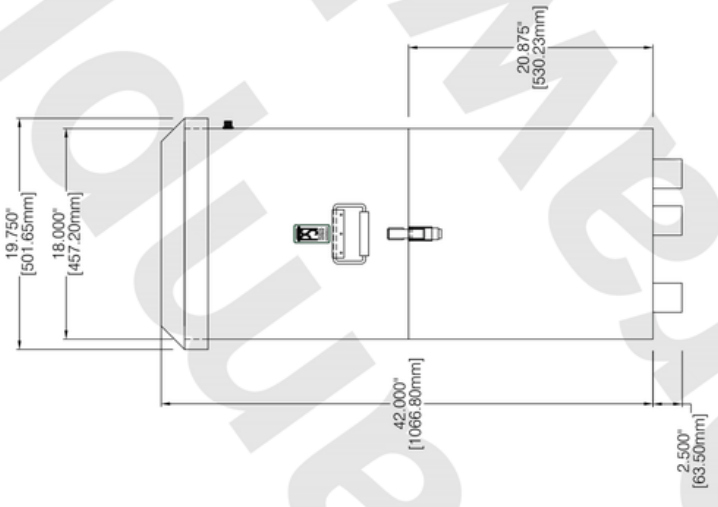
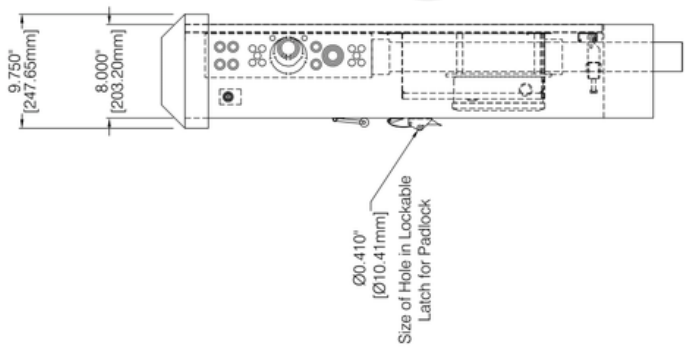

# SL42 Un-metered Pedestal (Listed Custom Layout)

# METERED

**10 YEAR  
WARRANTY**

**PEDESTALS SOLUTIONS INC**

---

*The Outdoor Enclosure & Power Distribution Experts*



**CANADIAN MADE**





## Testimonial



### Poirier Electric Limited

★★★★★

We love your product! we have used them on about half a dozen projects. It's so versatile and sleek looking!

NEMA 3R LISTED  
10 YEAR WARRANTY

# SLM27

## Metered Power Distribution Pedestal



## Features

- Complete with 2" PVC conduits for Line and Load Side conductors and a ground wire to bond the Neutral.
- Delivered "Ready to Install" with a Service Entrance rating, 22kA I.C. series rating, and ESA approval.
- Hardware to fasten pedestal to pre-cast concrete base is included with every pedestal (base available from many pre-cast concrete manufacturers).

### Typical Part Number

**SLM271-4-40(100)**

- SLM** - Street Lighting Metered Pedestal
- 27** - Size of Pedestal, 27"
- 1** - Number of first group of Load Breakers
- 4** - Quantity of Load Breakers
- 40** - Size of Load Breaker
- 100** - Size of Main Breaker

## → CONSTRUCTION

Constructed from heavy-gauge aluminum.

- Electrostatic powder coated "Equipment Green" as standard.
- All doors constructed to prevent weather intrusion without the means of a rubber gasket.
- Concealed Ventilation under lid to prevent condensation build-up.
- Stainless Steel fasteners used to mount all internal and external components.

## → MEASUREMENTS

Height - 27"  
Width - 18"  
Depth - 20"

## → TYPICAL USES

Street Lighting Power  
Park Power Distribution  
Electric Car Charging  
Event Power

CALL US TODAY



**905-476-7433**



[info@pedestalsolutions.com](mailto:info@pedestalsolutions.com)



[www.pedestalsolutions.com](http://www.pedestalsolutions.com)



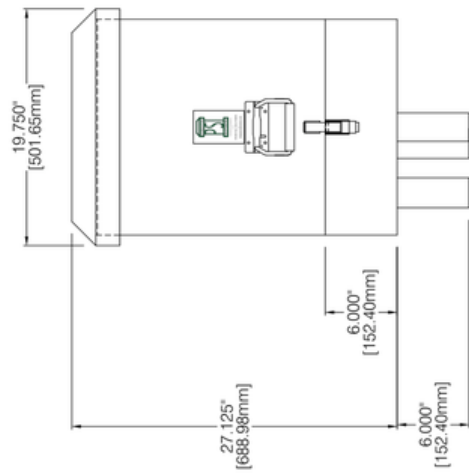

Meterbase Compartment  
Outside View  
with Panels in place

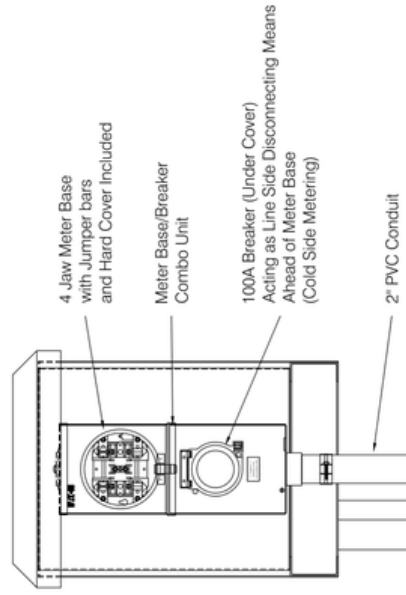

Meterbase Compartment  
Outside View  
with Front Panels Removed

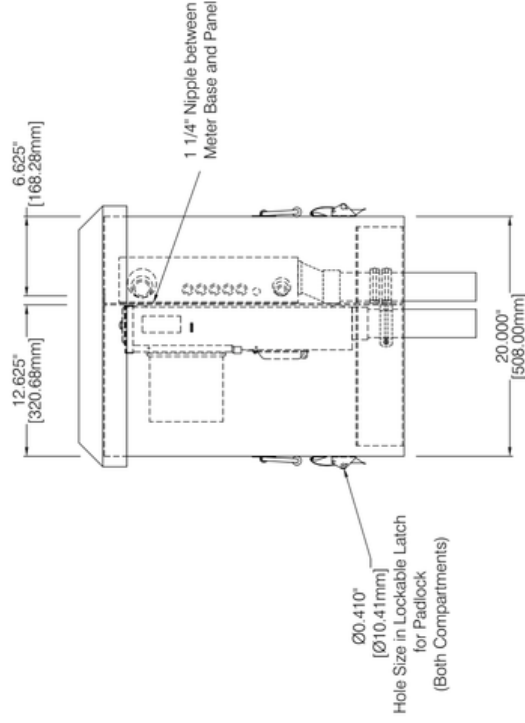

Outside Side View

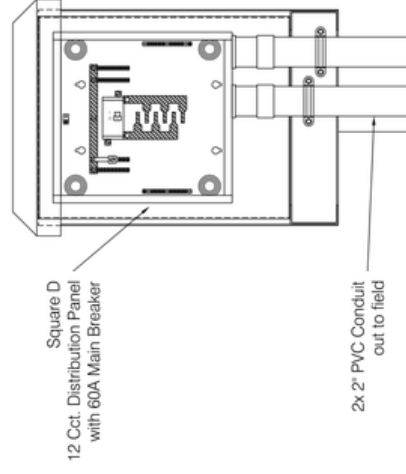

Distribution Panel Compartment  
Outside View  
with Front Panels Removed

# SLM27 Enclosure with Meterbase/Disconnect



## Testimonial



**Aaron Blata**



I love your products, especially the SLM42. I spec it everywhere!

NEMA 3R LISTED  
10 YEAR WARRANTY

# SLM42

Metered Power Distribution Pedestal



## Features

- Complete with PVC conduits for Line and Load Side conductors and a ground wire to bond the Neutral.
- Delivered "Ready to Install" with a Service Entrance rating, 22kA I.C. series rating, and ESA approval.
- Hardware to fasten pedestal to pre-cast concrete base is included with every pedestal (base available from many pre-cast concrete manufacturers).

### Typical Part Number

**SLM421-4-40(200)**

- SLM** - Street Lighting Metered Pedestal
- 42** - Size of Pedestal, 42"
- 1** - Number of first group of Load Breakers
- 4** - Quantity of Load Breakers
- 40** - Size of Load Breaker
- 200** - Size of Main Breaker

## → CONSTRUCTION

Constructed from heavy-gauge aluminum.

- Electrostatic powder coated "Equipment Green" as standard.
- All doors constructed to prevent weather intrusion without the means of a rubber gasket.
- Concealed Ventilation under lid to prevent condensation build-up.
- Stainless Steel fasteners used to mount all internal and external components.

## → MEASUREMENTS

Height - 42"

Width - 18"

Depth - 20"

## → TYPICAL USES

Street Lighting

LED Lighting Controls

Park Power

Electric Car Charging

Event Power

CALL US TODAY

**905-476-7433**



[info@pedestalsolutions.com](mailto:info@pedestalsolutions.com)



[www.pedestalsolutions.com](http://www.pedestalsolutions.com)

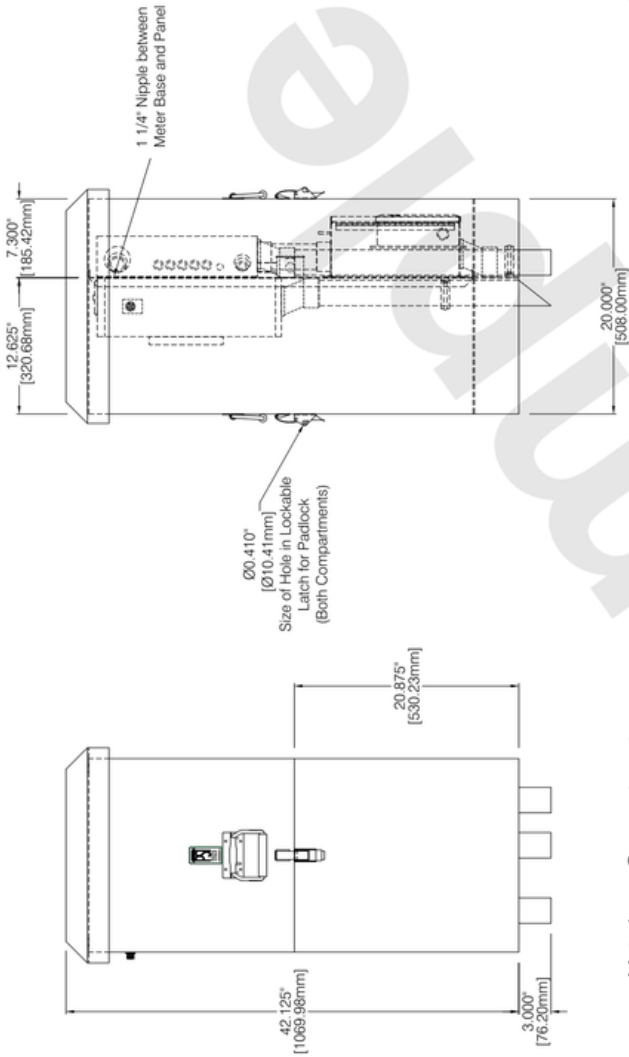

Meterbase Compartment  
Outside View  
with Door Panels in place

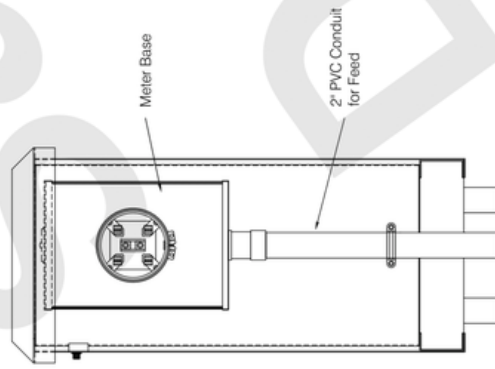

Meterbase Compartment  
Outside View  
with Door Panels Removed

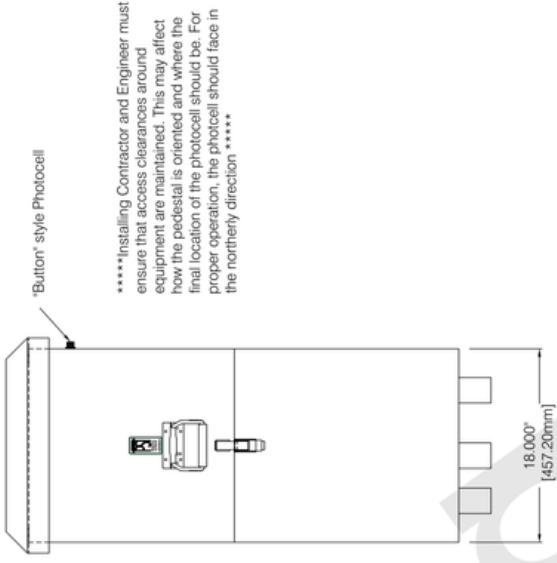

Distribution Panel Compartment  
Outside View  
with Door Panels in place

\*\*\*\*\*Installing Contractor and Engineer must ensure that access clearances around equipment are maintained. This may affect how the pedestal is oriented and where the final location of the photocell should be. For proper operation, the photocell should face in the northerly direction \*\*\*\*\*

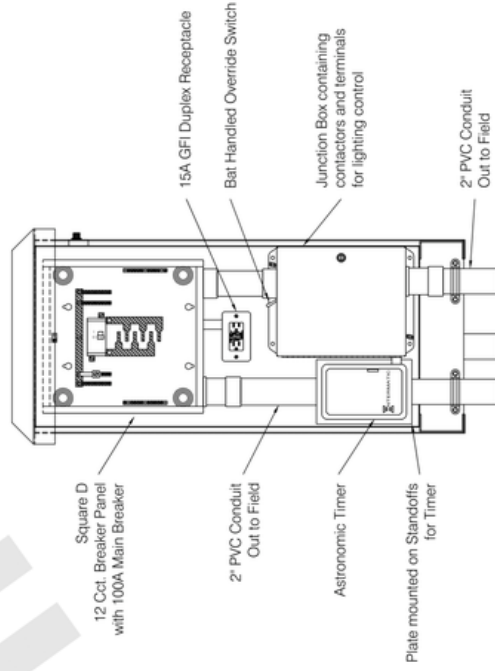

Distribution Panel Compartment  
Outside View  
with Door Panels Removed

## SLM42 Metered Pedestal (Listed Custom Layout)



## Testimonial



### Poirier Electric Limited

★★★★★

We love your product! we have used them on about half a dozen projects. It's so versatile and sleek looking!

NEMA 3R LISTED  
10 YEAR WARRANTY

# SLM60

## Metered Power Distribution Pedestal



## Features

- Complete with 2" PVC conduits for Line and Load Side conductors and a ground wire to bond the Neutral.
- Delivered "Ready to Install" with a Service Entrance rating, 22kA I.C. series rating, and ESA approval.
- Hardware to fasten pedestal to pre-cast concrete base is included with every pedestal (base available from many pre-cast concrete manufacturers).

### Typical Part Number

**SLM601-4-40(200)**

- SLM** - Street Lighting Metered Pedestal
- 60** - Size of Pedestal, 60"
- 1** - Number of first group of Load Breakers
- 4** - Quantity of Load Breakers
- 40** - Size of Load Breaker
- 200** - Size of Main Breaker

## → CONSTRUCTION

Constructed from heavy-gauge aluminum.

- Electrostatic powder coated "Equipment Green" as standard.
- All doors constructed to prevent weather intrusion without the means of a rubber gasket.
- Concealed Ventilation under lid to prevent condensation build-up.
- Stainless Steel fasteners used to mount all internal and external components.

## → MEASUREMENTS

Height - 60"

Width - 22"

Depth - 20"

## → TYPICAL USES

- Street Lighting
- Park Power
- Electric Car Charging
- Event Power
- LED Lighting Controls

CALL US TODAY

**905-476-7433**



[info@pedestalsolutions.com](mailto:info@pedestalsolutions.com)



[www.pedestalsoluitons.com](http://www.pedestalsoluitons.com)

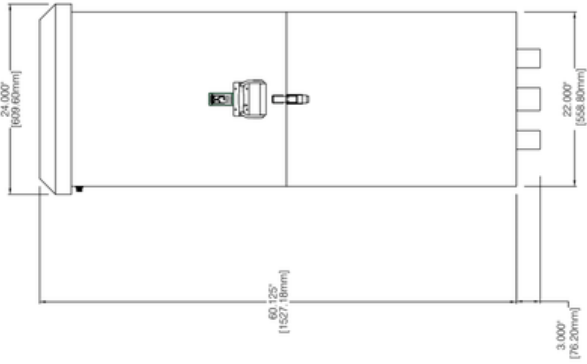

Meterbase Compartment  
Exterior View  
with Panels in place

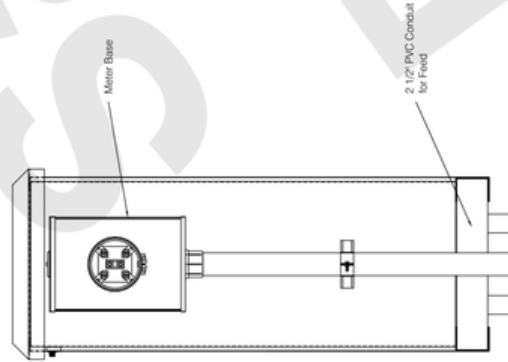

Meterbase Compartment  
Outside View  
with Panel Removed

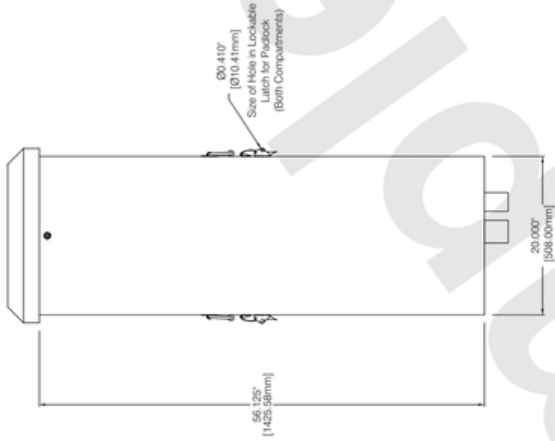

Exterior  
Side View

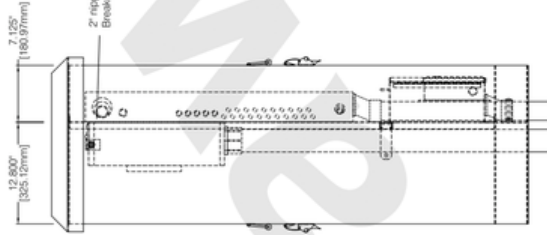

Side View

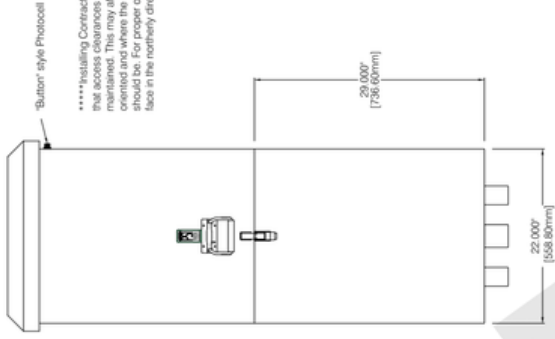

Distribution Panel Compartment  
Exterior View  
with Panels in place

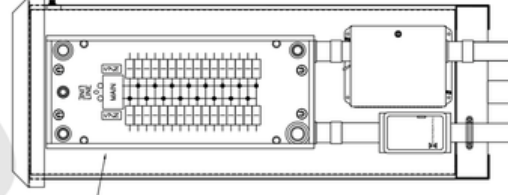

Distribution Panel Compartment  
Outside View  
with Panel Removed

\*\*\*\*\*Installing Contractor and Engineer must ensure that access clearances around equipment are maintained. This may affect how the pedestal is oriented and where the final location of the photocell should be. For proper operation, the photocell should face in the northerly direction \*\*\*\*\*

# SLM60 Metered Pedestal (Listed Custom Layout)



## Testimonial



### Poirier Electric Limited

★★★★★

We love your product! We have used them on about half a dozen projects. It's so versatile and sleek looking!

NEMA 3R LISTED  
10 YEAR WARRANTY

# SMT

## Metered Power Distribution Pedestal



## Features

- Complete with 2" PVC conduits for Line and Load Side conductors and a ground wire to bond the Neutral.
- Choice of meter bases to meet local Hydro Authority requirements. Meter mounted externally meets Hydro Authority meter height requirement.
- Delivered "Ready to Install" with a Service Entrance rating, 22kA I.C. series rating, and ESA approval.
- Hardware to fasten pedestal to pre-cast concrete base is included with every pedestal (base available from many pre-cast concrete manufacturers).

### Typical Part Number

**SMT1-4-40(200)**

- SMT** - Street Lighting Tall Pedestal
- 1** - Number of first group of Load Breakers
- 4** - Quantity of Load Breakers
- 40** - Size of Load Breaker
- 200** - Size of Main Breaker

## → CONSTRUCTION

Constructed from heavy-gauge aluminum.

- Electrostatic powder coated "Equipment Green" as standard.
- All doors constructed to prevent weather intrusion without the means of a rubber gasket.
- Concealed Ventilation under lid to prevent condensation build-up.
- Stainless Steel fasteners used to mount all internal and external components.

## → MEASUREMENTS

Height - 74"

Width - 18"

Depth - 8"

## → TYPICAL USES

- Street Lighting
- Park Power
- Electric Car Charging
- Event Power

CALL US TODAY



**905-476-7433**



[info@pedestalsolutions.com](mailto:info@pedestalsolutions.com)



[www.pedestalsolutions.com](http://www.pedestalsolutions.com)

\*\*\*\*\*Installing Contractor and Engineer must ensure that access clearances around equipment are maintained. This may affect how the pedestal is oriented and where the final location of the photocell should be. For proper operation, the photocell should face in the northerly direction and away from direct sources of light \*\*\*\*\*

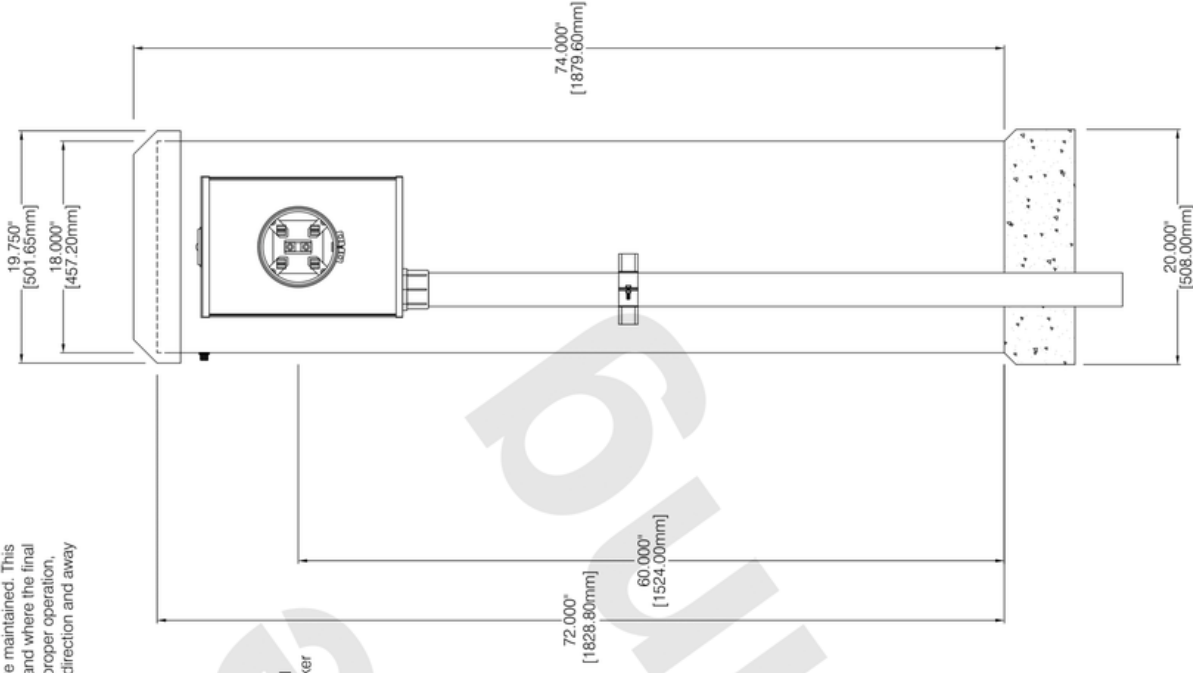

Rear View

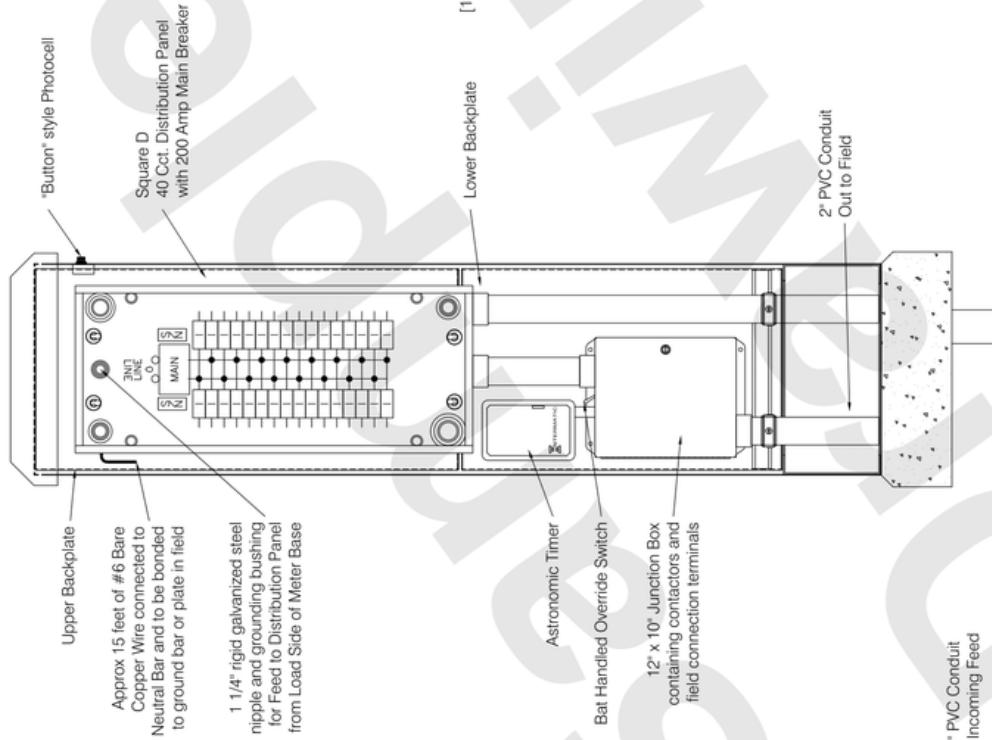

Front View  
with Front Covers Removed

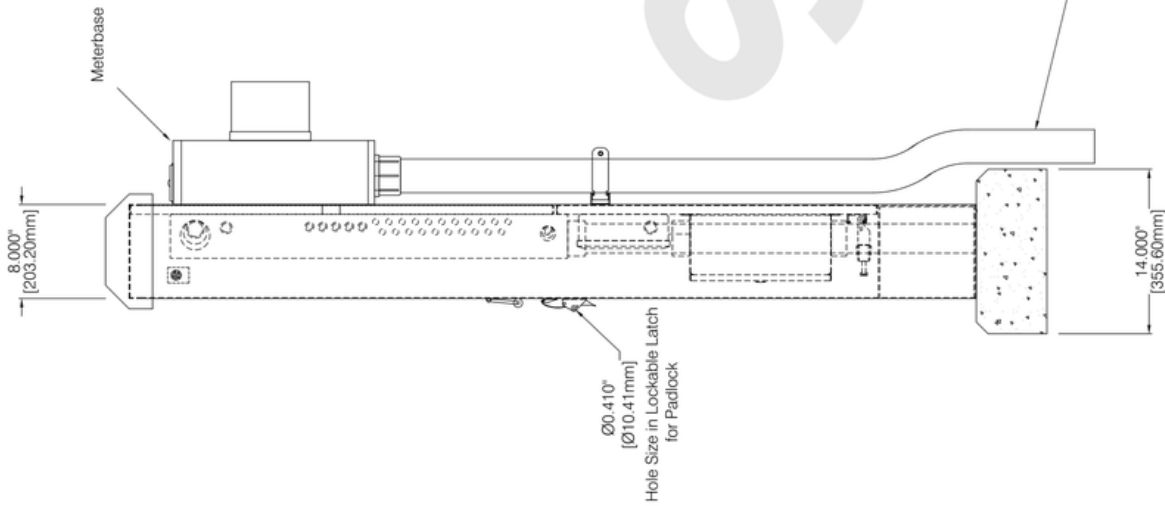

Side View  
with Front Covers Installed

## SMT Metered Pedestal (Listed Custom Layout)



**Town of Halton Hills**



Your help and service this year was great! Our contractor and staff love the simplicity of the installation and use!

NEMA 3R LISTED  
10 YEAR WARRANTY

# DWM42

Double Wide Metered Power  
Distribution Pedestal



## Features

- Complete with 2" PVC conduits for Line and Load Side conductors and a ground wire to bond the Neutral.
- Delivered "Ready to Install" with a Service Entrance rating, 22kA I.C. series rating, and ESA approval.
- Hardware to fasten pedestal to pre-cast concrete base is included with every pedestal (base available from many pre-cast concrete manufacturers).

## → CONSTRUCTION

Constructed from heavy-gauge aluminum.

- Electrostatic powder coated "Equipment Green" as standard.
- All doors constructed to prevent weather intrusion without the means of a rubber gasket.
- Concealed Ventilation under lid to prevent condensation build-up.
- Stainless Steel fasteners used to mount all internal and external components.

## → MEASUREMENTS

Height - 42"

Width - 36"

Depth - 20"

## → TYPICAL USES

Street Lighting  
Park Power  
Electric Car Charging  
Event Power

LED Lighting Controls  
Metered and Unmetered Power

**Typical Part Number**  
**DWM421-4-40(200)**

**DWM** - Double Wide Metered Pedestal  
**42** - Size of Pedestal, 42"  
**1** - Number of first group of Load Breakers  
**4** - Quantity of Load Breakers  
**40** - Size of Load Breaker  
**200** - Size of Main Breaker

CALL US TODAY

**905-476-7433**



[info@pedestalsolutions.com](mailto:info@pedestalsolutions.com)



[www.pedestalsolutions.com](http://www.pedestalsolutions.com)



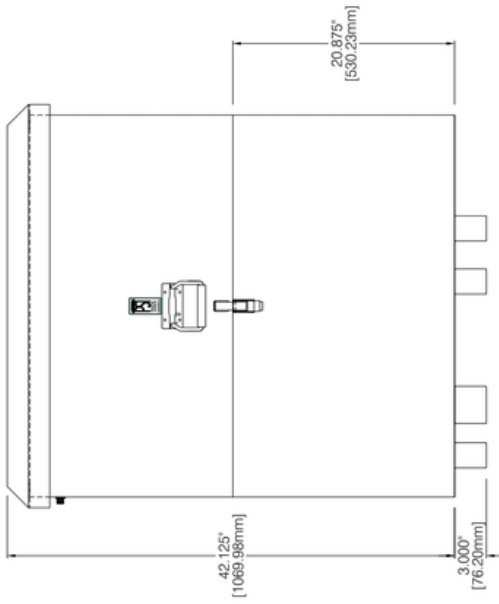

Meterbase Compartment  
Outside View  
with Panel in place

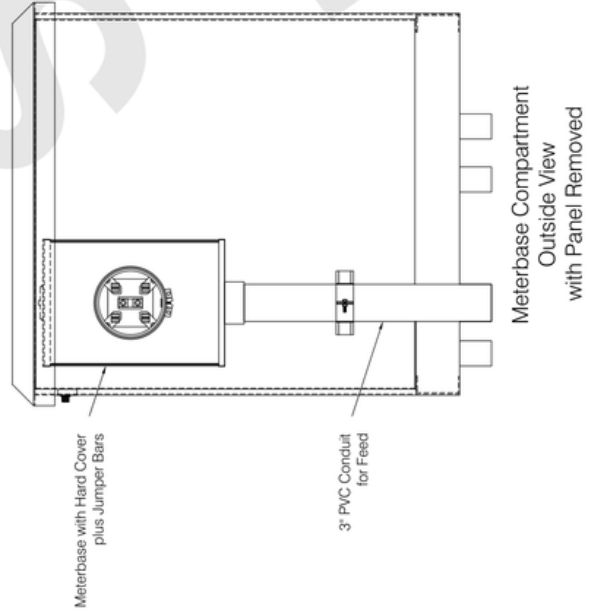

Meterbase Compartment  
Outside View  
with Panel Removed

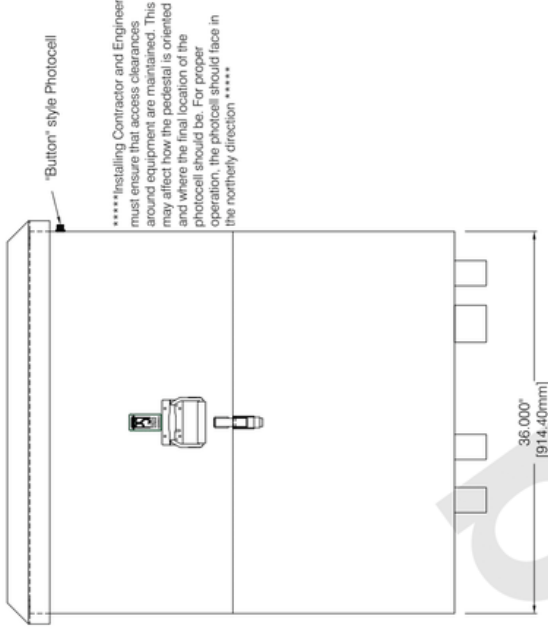
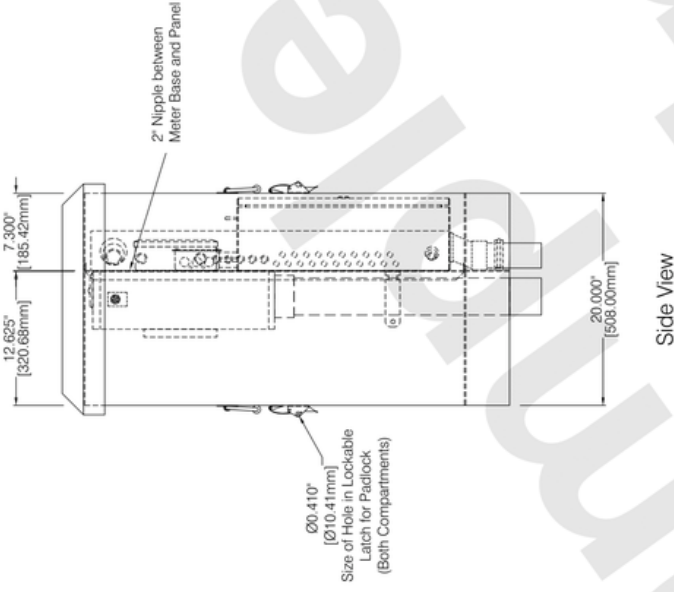

Distribution Panel Compartment  
Outside View  
with Panel in place

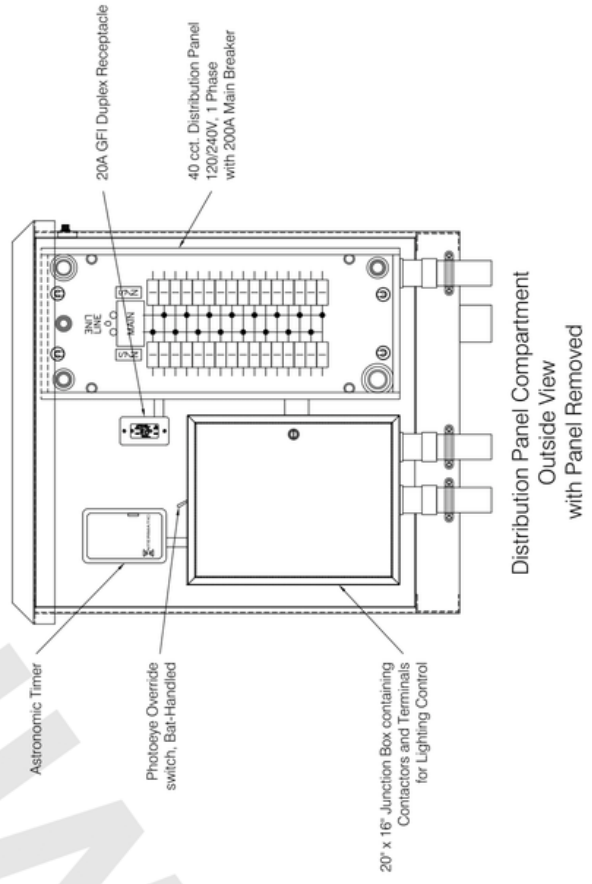

Distribution Panel Compartment  
Outside View  
with Panel Removed

\*\*\*\*\*Installing Contractor and Engineer must ensure that access clearances around equipment are maintained. This may affect how the pedestal is oriented and where the final location of the photocell should be. For proper operation, the photocell should face in the northerly direction \*\*\*\*\*

## DWM42 Metered Pedestal (Listed Custom Layout)

# TEMPORARY USE

**10 YEAR  
WARRANTY**

**PEDESTALS SOLUTIONS INC**

---

*The Outdoor Enclosure & Power Distribution Experts*



**CANADIAN MADE**





## Testimonial



### Town of Halton Hills



Your help and service this year was great! Our contractor and staff love the simplicity of the installation and use!

NEMA 3R LISTED  
10 YEAR WARRANTY

# PP-39

## Park Pedestal



## Features

- Can be mounted on any surface. Wood, Concrete, Direct Burial (Requires additional below grade base plate)
- Delivered "Ready to Install", and ESA approval.
- Hardware to fasten pedestal is included with baseplate for above grade Pedestal mount.

- Concealed Ventilation under lid to prevent condensation build-up.
- Stainless Steel fasteners used to mount all internal and external components.
- Circuit breakers within pedestal, or without.
- Typically provided with weather proof lockable covers, but optional heavy duty in-use covers can be provided.

### → CONSTRUCTION

Constructed from heavy-gauge aluminum.

- Electrostatic powder coated "Equipment Green" as standard.
- All doors constructed to prevent weather intrusion without the means of a rubber gasket

### → MEASUREMENTS

Height - 39"

Width - 6"

Depth - 6"

### → TYPICAL USES

Rv/ Campside Power & Water Connections  
 Park Power & Water Connections  
 Marine Dock/Deck Power & Water Connections  
 Event Pedestal Power & Water Connections



CALL US TODAY

905-476-7433



info@pedestalsolutions.com



www.pedestalsoluitons.com

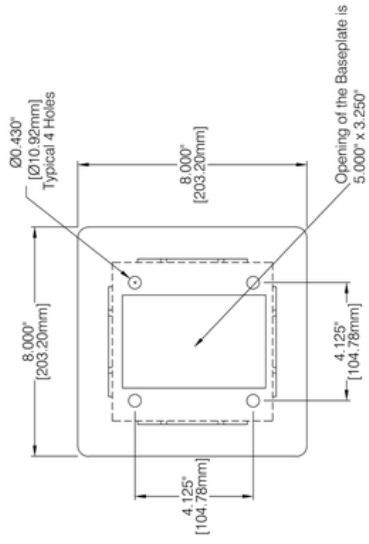

Baseplate (Magnified 2x)

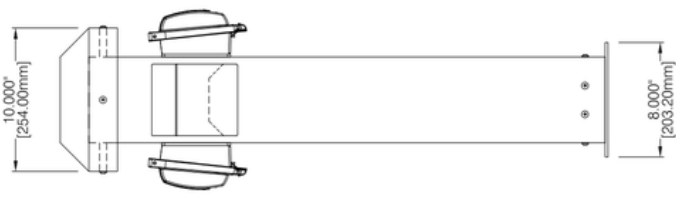

Front Outside View

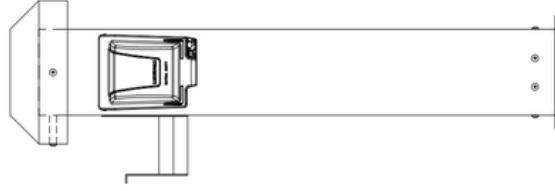

Right Outside View

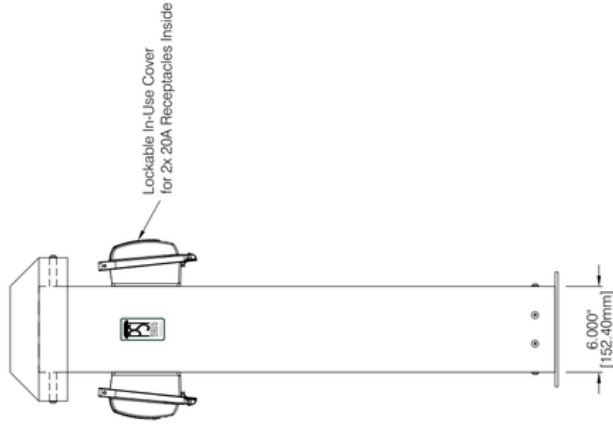

Rear Outside View

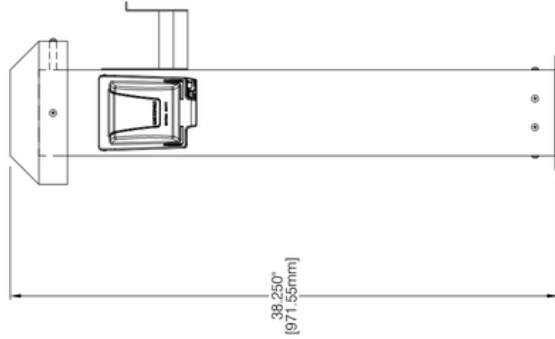

Left Outside View

# RV/Park/Marine Pedestal with 4x Receptacles With "In Use" Covers with one Hose Rack



## Testimonial



### Town of Halton Hills



Your help and service this year was great! Our contractor and staff love the simplicity of the installation and use!

NEMA 3R LISTED  
10 YEAR WARRANTY

# PP-XL

## Marine Pedestal



## Features

- 15 - 50amp Straight Blade Connections
- 15 - 50amp Twist lock Connections
- Two 100 watt smart lights for in-direct lighting
- Optional Hose Hanger Bracket
- Lockable well not "In'-Use" Covers
- Photocell allowing for lighting control
- AV Controls
- Dual Hose Bibs for water access
- Customizable to your requirements



## → CONSTRUCTION

We Built this unit to last. And we back that with a 10 Year Warranty.

- Made of Thick 5052 Aluminum
- Or upgrade to 316 Stainless Steel
- Finished with a UV and Corrosion Protectant Powder Coat
- Built to thrive in Canada's harsh winters

## → MEASUREMENTS

Height - 42"

Width - 10"

Depth - 10"

## → TYPICAL USES

- |          |                        |
|----------|------------------------|
| Marina   | Boat Houses            |
| RV Sites | Promenades             |
| Docks    | Water Front Boulevards |

CALL US TODAY



**905-476-7433**



[info@pedestalsolutions.com](mailto:info@pedestalsolutions.com)



[www.pedestalsolutions.com](http://www.pedestalsolutions.com)

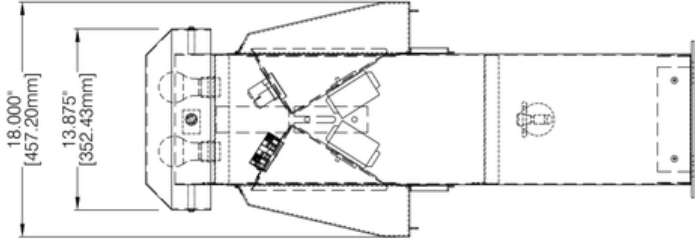

Rear Outside View  
with Panel

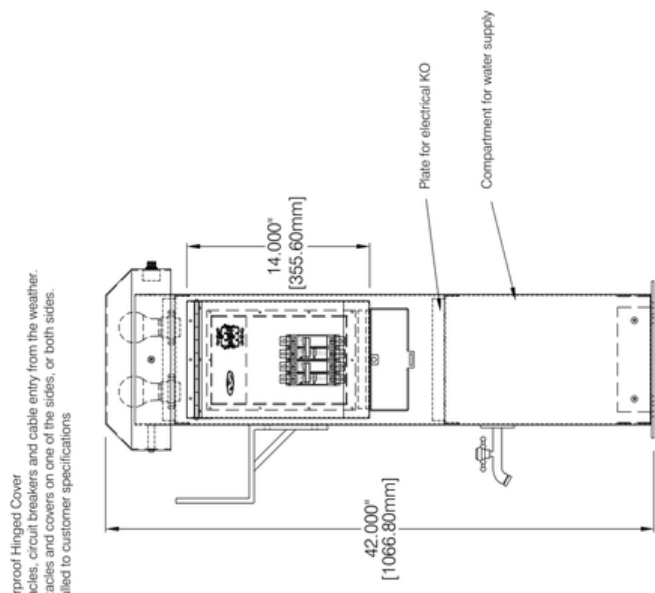

Right Outside View

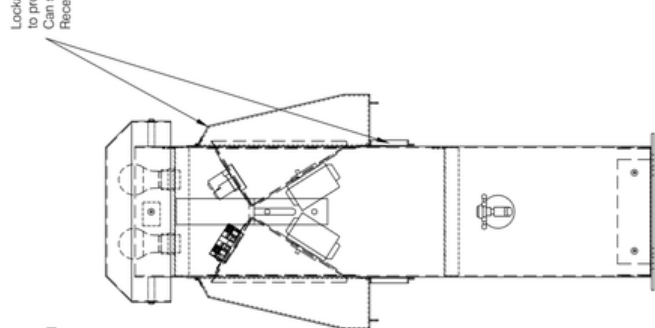

Front Outside View

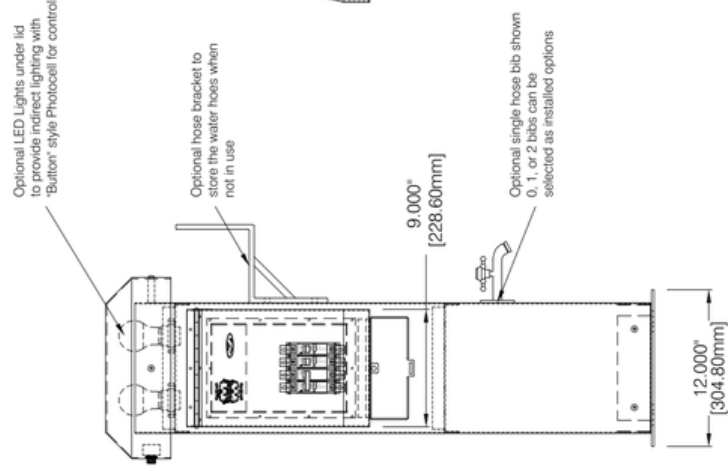

Left Outside View

Lockable Weatherproof Hinged Cover  
to protect receptacles, circuit breakers and cable entry from the weather.  
Can select receptacles and covers on one of the sides, or both sides.  
Receptacles installed to customer specifications

Optional LED Lights under lid  
to provide indirect lighting with  
"Button" style PhotoCell for control

Optional hose bracket to  
store the water hoses when  
not in use

Optional single hose bib shown  
0, 1, or 2 bibs can be  
selected as installed options

# Marine/Park Pedestal Layouts

# CUSTOM

**10 YEAR  
WARRANTY**

**PEDESTALS SOLUTIONS INC**

---

*The Outdoor Enclosure & Power Distribution Experts*



**CANADIAN MADE**





**Poirier Electric Limited**



We love your product! We have used them on about half a dozen projects. It's so versatile and sleek looking!

NEMA 3R LISTED  
10 YEAR WARRANTY

# HHB

## Hand Hole Breaker



### Features

- Fits into most concrete and steel lighting poles' hand hole.
- Service entrance rated.
- Completely pre-wired.
- ESA Approved.
- Single pole or 2-pole, 15A or 50A, 22kA I.C. rated versions.

### → CONSTRUCTION

- #6 AWG line and load conductors on 50A units
- #10 AWG line and load conductors on 15A units.
- #14 AWG load conductor for feeding the light.

### → MEASUREMENTS

Height - 9"  
Width - 2"  
Depth - 4"

| Cat. No. | Description              | Breaker            | Dimensions                                            |
|----------|--------------------------|--------------------|-------------------------------------------------------|
| SL1-15   | 120 Volt In-Pole Breaker | Single Pole 15 Amp | 228mm H x 55mm W x 105mm<br>8.85" H x 2.16" W x 4.13" |
| SL1-50   | 120 Volt In-Pole Breaker | Single Pole 50 Amp | 228mm H x 55mm W x 105mm<br>8.85" H x 2.16" W x 4.13" |
| SL2-15   | 120/240V In-Pole Breaker | Two Pole 15 Amp    | 228mm H x 55mm W x 105mm<br>8.85" H x 2.16" W x 4.13" |
| SL2-50   | 120/240V In-Pole Breaker | Two Pole 50 Amp    | 228mm H x 55mm W x 105mm<br>8.85" H x 2.16" W x 4.13" |

CALL US TODAY

**905-476-7433**



[info@pedestalsolutions.com](mailto:info@pedestalsolutions.com)



[www.pedestalsolutions.com](http://www.pedestalsolutions.com)



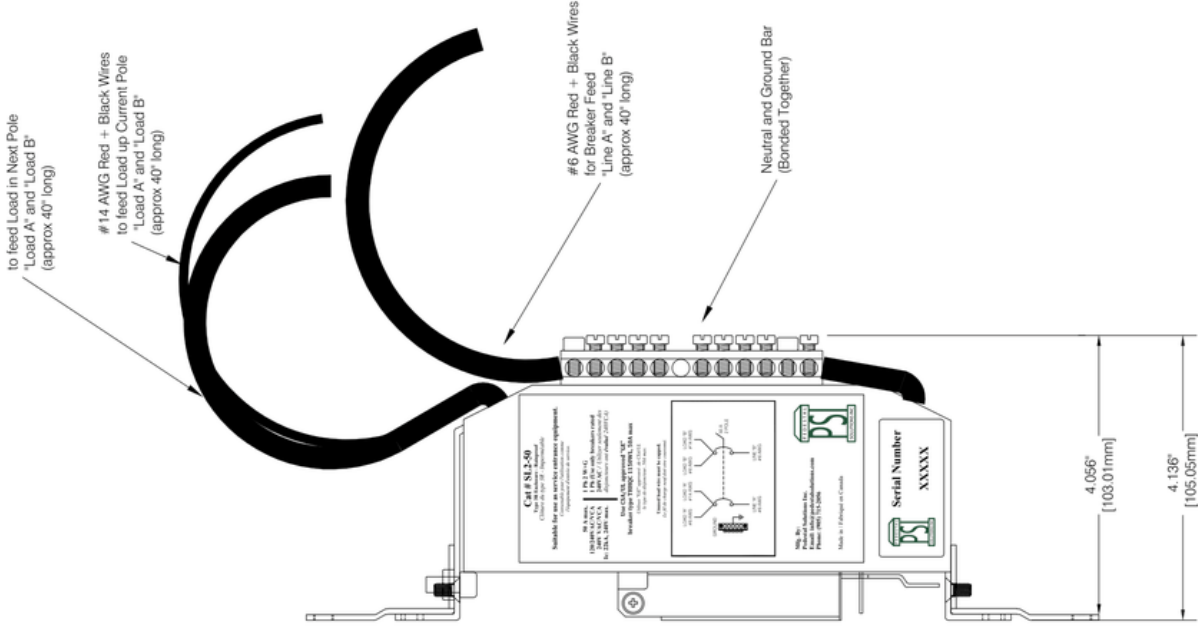

Side View with  
Locking Cover in Place

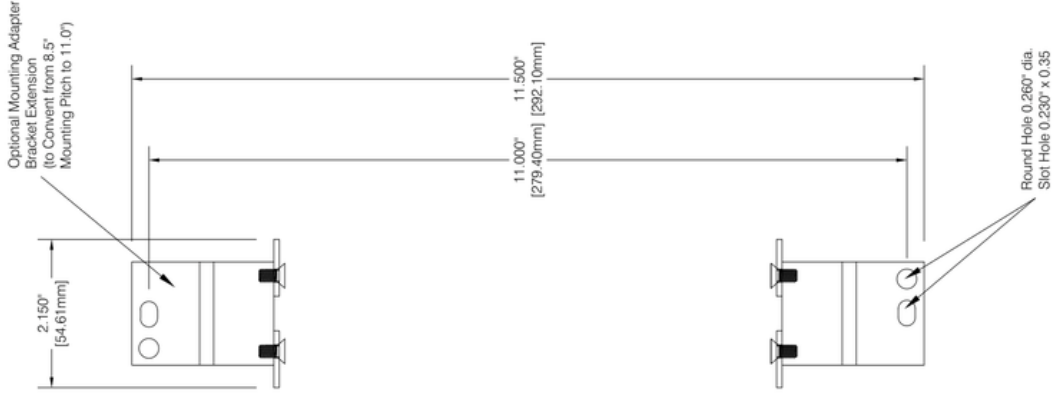

Front View with  
Locking Cover in Place

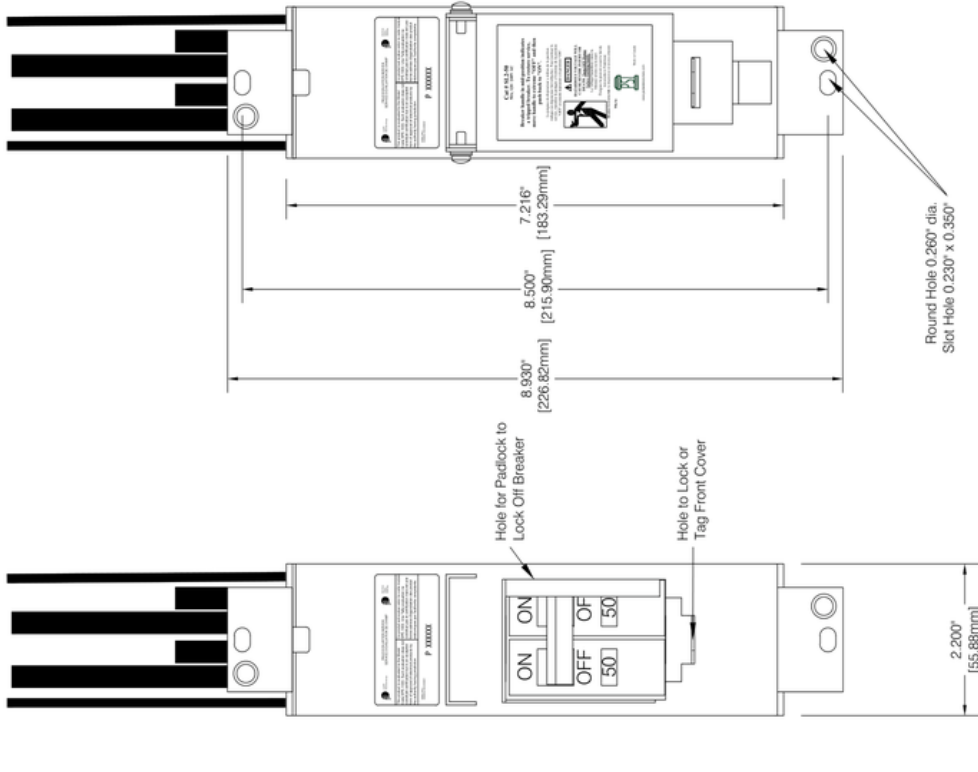

Front View with  
Locking Cover Removed

# Hand Hole Breaker (Service Entrance Rated) SL2 - 50 with 50A Two Pole Breaker



## Testimonial



### Makuta Electric LLC



I have to say, I am very impressed with the product and your entire team. I will highly recommend your company to all my fellow electrical contractors in the area.

NEMA 3R LISTED  
10 YEAR WARRANTY

# LVTC

## Low Voltage Termination Cabinet



## Features

- Available for 120-600VAC in both Single-Phase and Three-Phase configurations.
- Designed to replace “flush to grade” junction boxes
- Ideal for sub-divisions to increase the number of termination spots per transformer.
- Lifting Eye Nuts provided on either side to allow for easy lifting with crane.

- Concealed Ventilation under lid to prevent condensation build-up.
- Lifting Eye Nuts provided on either side to allow for easy lifting with crane.
- Stainless Steel fasteners used to mount all internal and external components.
- Access door fastened with Penta Bolt and is also padlockable.

### → CONSTRUCTION

- Constructed from heavy gauge galvanized steel and electrostatic powder coated “Equipment Green” as standard.
- All doors constructed to prevent weather intrusion without the means of a rubber gasket

### → MEASUREMENTS

Height - 42"  
Width - 18"  
Depth - 20"

### → TYPICAL USES

Used in conjunction with Transformers to reduce number of road crossings, saving on wire and restoration.

CALL US TODAY

905-476-7433



info@pedestalsolutions.com



www.pedestalsoluitons.com

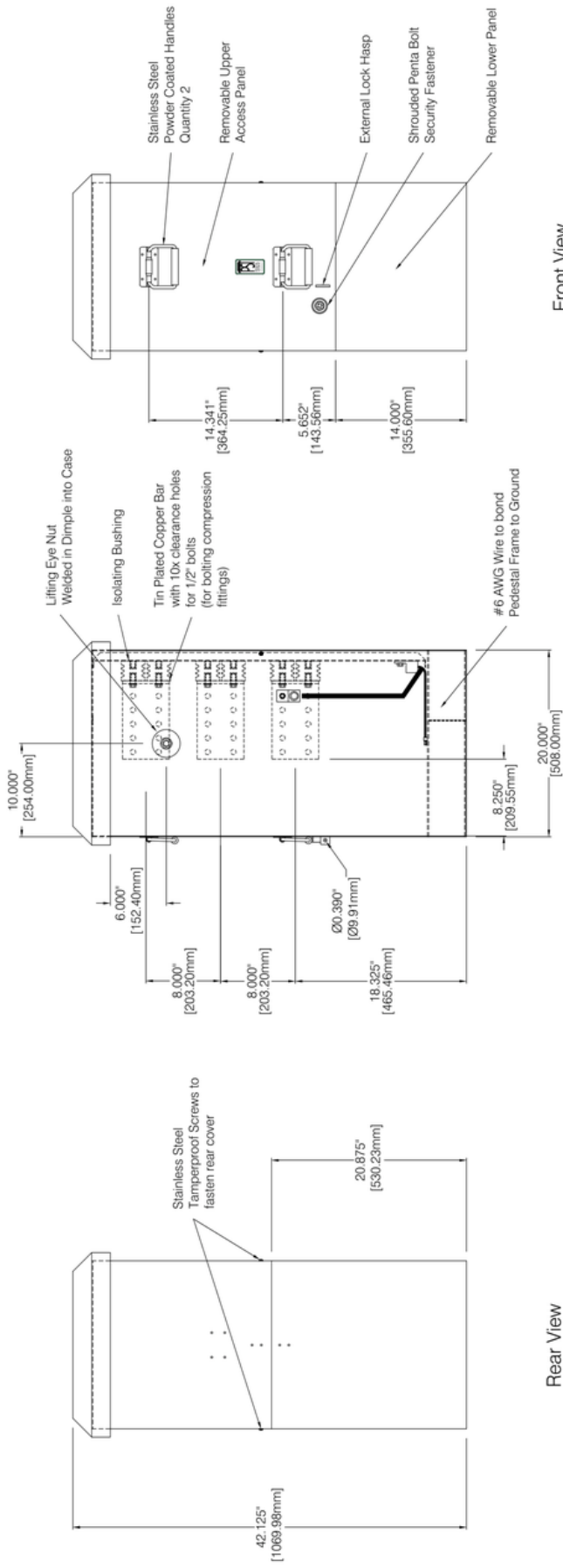

Rear View Spare Compartment Outside with Panel in place

Side View

Front View of Connection Compartment with Panel in place

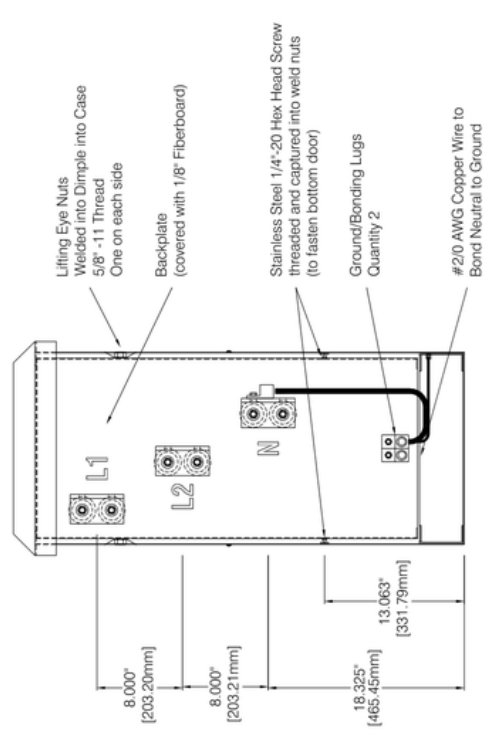
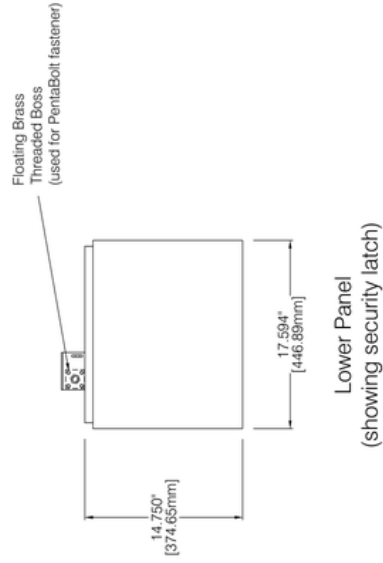

Front View of Connection Compartment with Lower Panel Removed

# Low Voltage Termination Cabinet



I have to say, I am very impressed with the product and your entire team. I will highly recommend your company to all my fellow electrical contractors in the area.

NEMA 3R LISTED  
10 YEAR WARRANTY

# LED CONTROL ENCLOSURE

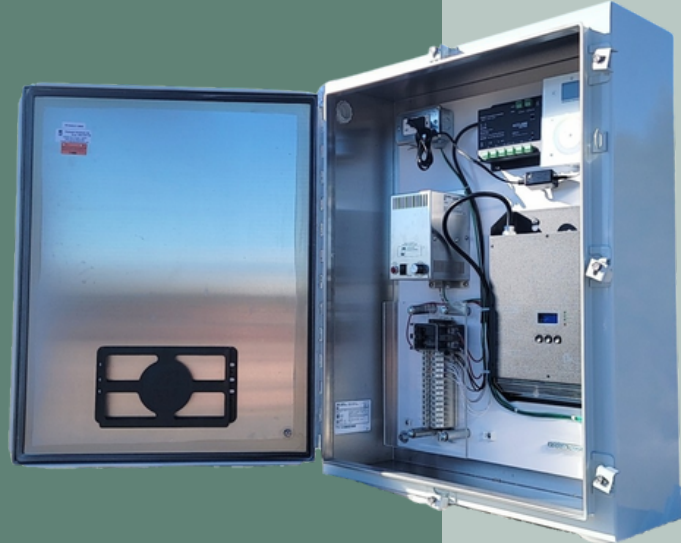

## Features

- Fully Automated Lighting Controls. Inside a temperature controlled, self-ventilated enclosure.
- Can be freestanding or wall / post mountable.
- Includes heaters, ventilation, terminals, contactors, Opti-Splitters, Drivers, DMX Decoders, all mounted and wired, ready for use.
- Delivered "Ready to Install" with an electrical approval sticker provided.
- We offer solutions for any application. We can shrink or grow your enclosure based on your project specific requirements.

- Can be made of 5052 Aluminum or Upgraded to 316 Stainless Steel.
- Concealed Ventilation to prevent condensation build-up.
- All units come with a 10 Year Warranty.



## MEASUREMENTS

Height - 27"

Width - 21"

Depth - 6"



## TYPICAL USES

- LED Bridge Lighting
- Event LED Lighting
- Pedestrian Pathway Lighting
- Driveway Strip Lighting
- Parks Lighting



## CONSTRUCTION

- Constructed from heavy-gauge aluminum or Stainless Steel.
- Electrostatic powder coated "Equipment Green" as standard or any colour requested.

CALL US TODAY



**905-476-7433**



[info@pedestalsolutions.com](mailto:info@pedestalsolutions.com)



[www.pedestalsolutions.com](http://www.pedestalsolutions.com)

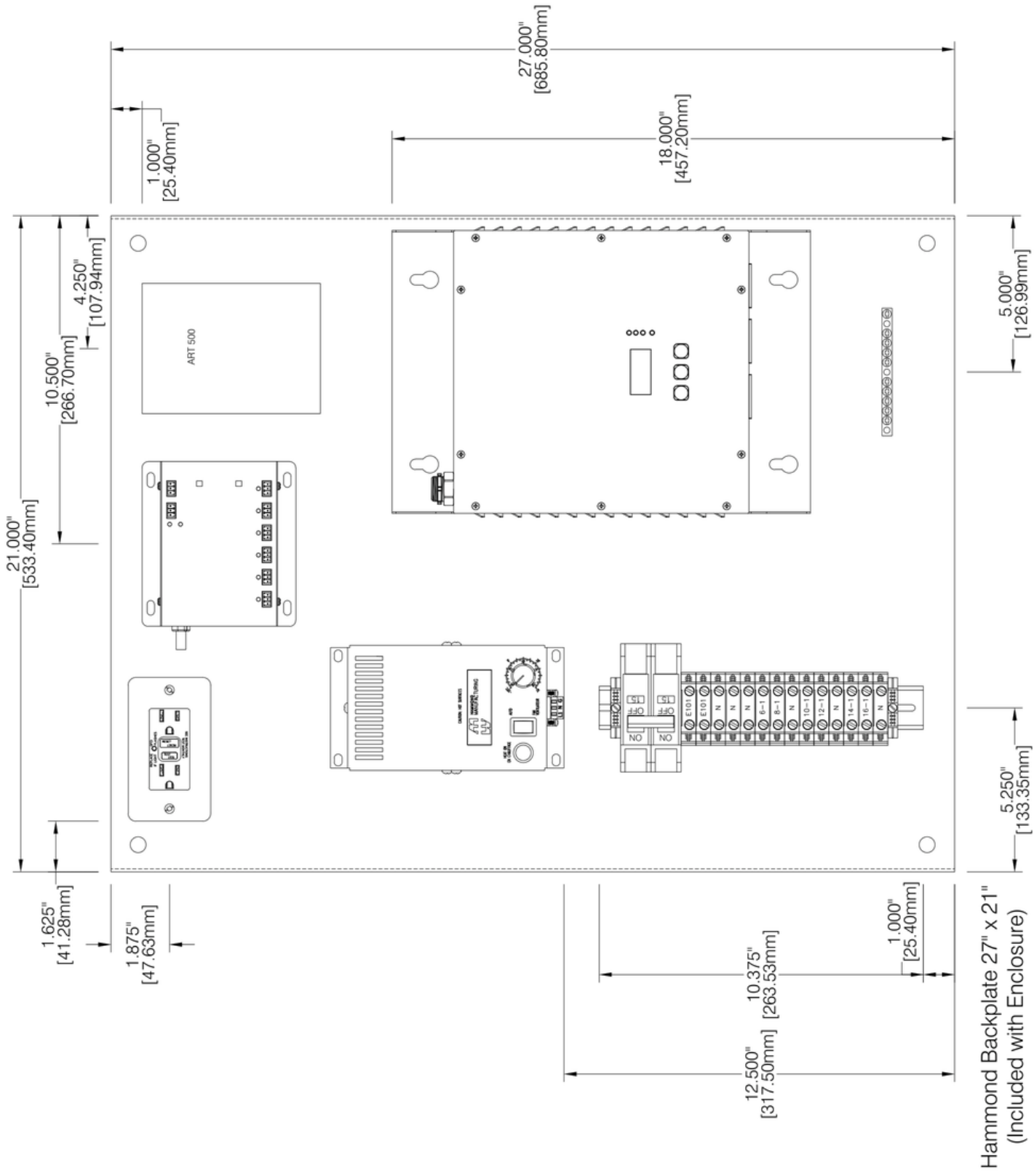

Hammond Backplate 27" x 21"  
(Included with Enclosure)

# LED Lighting Junction Box Backplate Layout East 1

# ACCESSORIES

**PEDESTALS SOLUTIONS INC**

---

*The Outdoor Enclosure & Power Distribution Experts*



**CANADIAN MADE**





# CONCRETE BASE



## Features

- No forming, and pouring concrete onsite. No down time / Big savings.
- Concrete Bases specifically designed to match up with PSI Pedestals.
- Knockouts and Open bottom allow for a wide range of cable/conduit runs.
- As a standard 42" Deep, getting below the frost line, preventing frost heave.
- Large inventory of Concrete bases, allowing for minimal lead time.

## → CONSTRUCTION

- Concrete Properties: 4500 PSI (32 MPa)  
Min Strength 6-8% Air Entrainment
- Six (6) 1/2" N.C. Nylon threaded inserts
- Six (6) Cable entry PVC seals
- Four (4) 3/4" Through holes for lifting into place.

| Pedestal Model | Base Size (L x W) |
|----------------|-------------------|
| SLS            | 14" by 20"        |
| SL42           | 14" by 20"        |
| SMT            | 14" by 20"        |
| SLM27          | 20" by 22"        |

| Pedestal Model | Base Size (L x W)        |
|----------------|--------------------------|
| SLM42          | 20" by 22"               |
| LVTC           | 20" by 22" or 36" by 36" |
| SLM60          | 20" by 22"               |
| DWM            | 22" by 38"               |

CALL US TODAY



**905-476-7433**



[info@pedestalsolutions.com](mailto:info@pedestalsolutions.com)



[www.pedestalsoluitons.com](http://www.pedestalsoluitons.com)



# POLE/POST MOUNT SL SERIES



## Features

- Adjustable Angle Iron allows for mounting on almost any shaped pole / post.
- Entire unit made of Aluminum, keeping it lite for handling and installing.
- Designed to maintain Nema 3R rating.
- Suppled hardware to allow for easy adjustment of angle iron.
- Able to mount to Square or Round pole.



## CONSTRUCTION

- U-Channel mounted to back of SL Series Pedestals
- Adjustable Angle Iron (Aluminum) connected to U-Channel

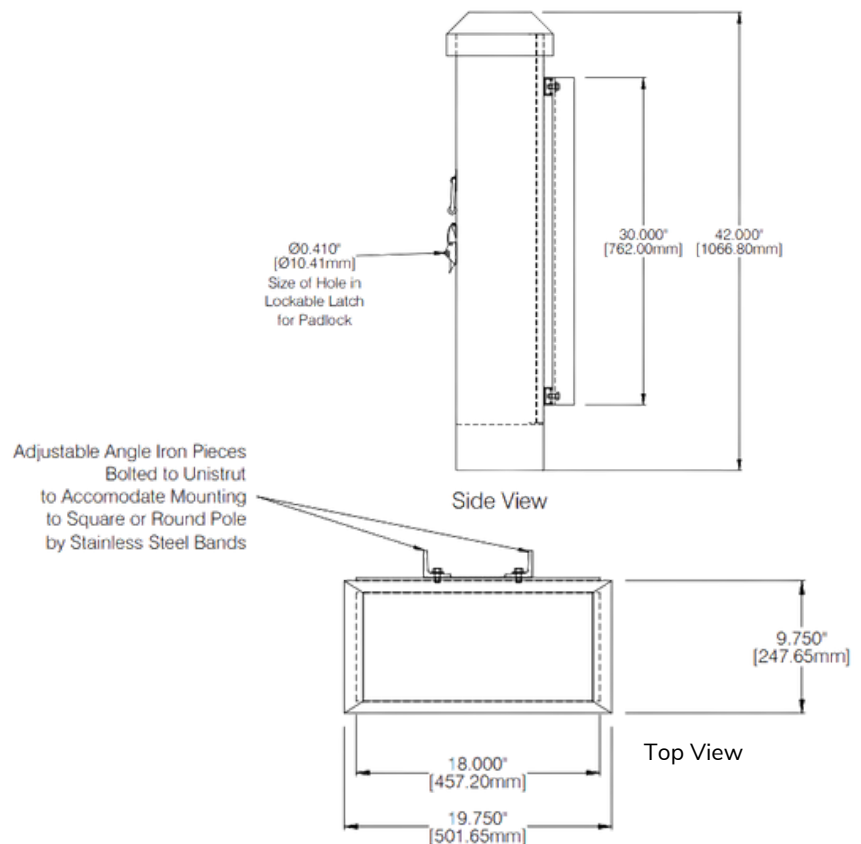

CALL US TODAY



905-476-7433



info@pedestalsolutions.com



www.pedestalsoluitons.com



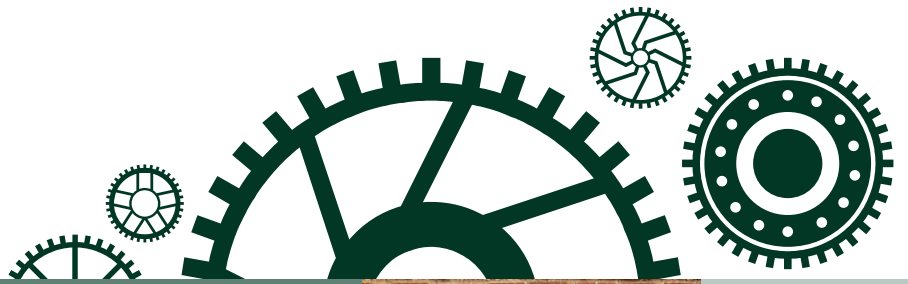

# WALL MOUNT



## Features

- Adjustable Unistrut allows for mounting on almost any wall.
- Comes with Channel Nut connection of Pedestal to Wall mounted Unistrut.
- Allows for easy modification of height of pedestal on wall.
- Entire unit made of Aluminum, keeping it lite for handling and installing.
- Meets Nema 3R rating.
- Suppled hardware to allow for easy adjustment of unit on wall.
- Only require a concrete drill, wrenches and a level to complete installation

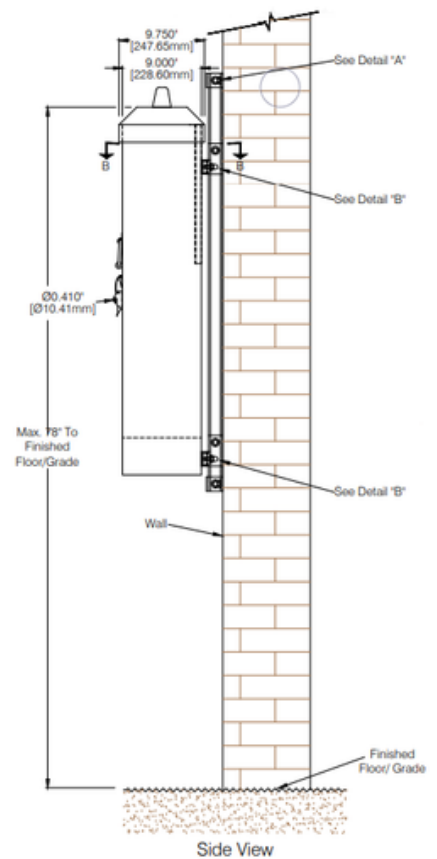

## CONSTRUCTION

- U-Channel mounted to back of SL Series Pedestals
- Adjustable 5 Hole “U” fitting Unistrut to mount on wall
- Bottom plate supplied with punched knockouts
- Weather-head can be added to side of Pedestal

CALL US TODAY



**905-476-7433**



[info@pedestalsolutions.com](mailto:info@pedestalsolutions.com)



[www.pedestalsolutions.com](http://www.pedestalsolutions.com)